

BASYS® Capacitance Sensing Activated

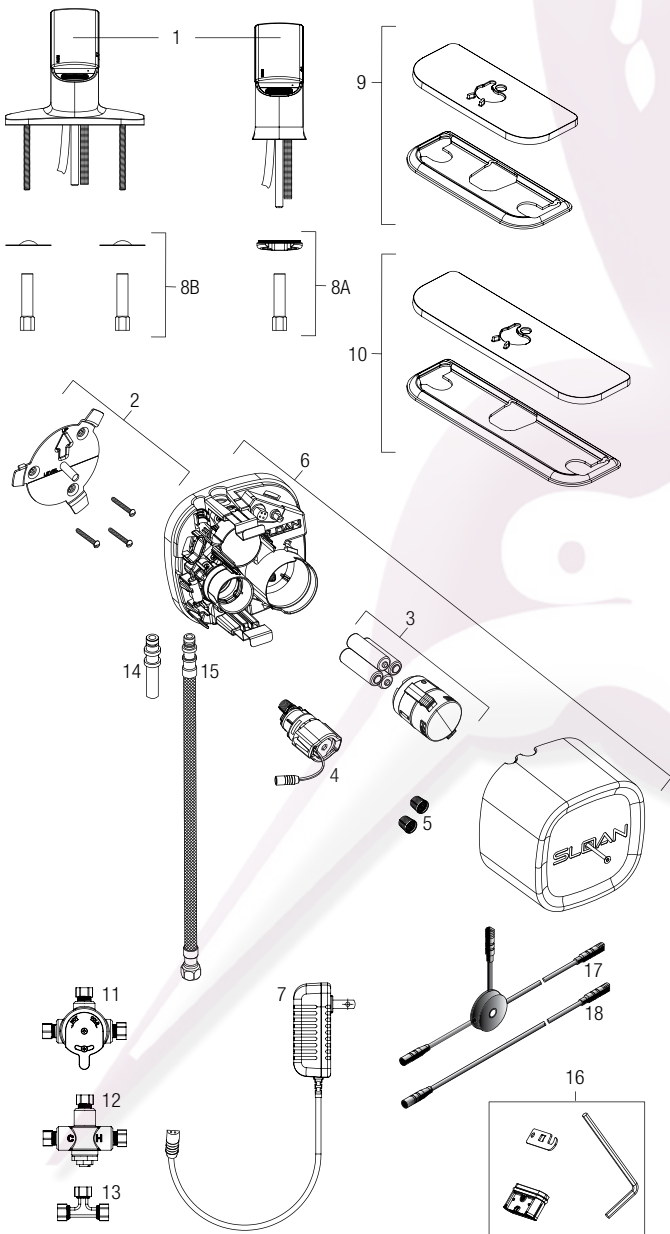

PARTS LIST—BASYS FAUCETS

Item No.	Code No.	Part No.	Description
1.	0324002	EFX-2	Standard Crown
2.	0324036	EFX-36	Control Module Mounting Kit
3.	3324113	EFX-8	Battery Pack
4.	0324014	EFX-13	Solenoid Valve Caddy 0.5 gpm (1.9 Lpm)
	0329015	EFX-14	Solenoid Valve Caddy 1.5 gpm (5.7 Lpm)
5.	0324019	EFX-19	Filter / Strainers
6.	3324105	EFX-1003-A	Control Module Assembly – 0.5 gpm (1.9 Lpm)
	3324106	EFX-1004-A	Control Module Assembly with Turbine – 0.5 gpm (1.9 Lpm)
	3324107	EFX-1005-A	Control Module Assembly – 1.5 gpm (5.7 Lpm)
	3324108	EFX-1006-A	Control Module Assembly with Turbine – 1.5 gpm (5.7 Lpm)
7.	0324031	EFX-31	120 VAC/6.75 VDC Plug-in Voltage Adapter
8A.	0335000	EAF-1	Faucet Spout Mounting Kit (Pedestal)
8B.	0324021	EFX-21-A	Faucet Spout Mounting Kit (Integrated Base)
9.	3324100	EFX-20-A	4-inch (102 mm) Centerset Base Plate Kit
10.	3324101	EFX-26-A	8-inch (203 mm) Centerset Base Plate Kit
11.	3326009	MIX-60-A	Below Deck Mechanical Mixing Valve
12.	0326045	MIX-135-A	Below Deck Thermostatic Mixing Valve
13.	0324033	ETF-617-A	Bak-Chek® Tee
14.	0324034	EFX-33	Inlet Hose Fitting
15.	3324102	EFX-34	Flexible Supply Hose 18" (45 mm)
16.	3324104	EFX-1002-A	0.5 gpm (1.9 Lpm) Multi-Lam Spray Insert, includes: insert, o-ring, insert removal tool, and hex key
	3324103	EFX-1001-A	1.5 gpm (5.7 Lpm) Aerated Stream Insert includes: insert, o-ring, insert removal tool, and hex key
	3324102	EFX-1000-A	1.5 gpm (5.7 Lpm) Laminar Stream Insert includes: insert, o-ring, insert removal tool, and hex key
17.	0335023	EAF-23-A	Splitter
18.	0335024	EAF-24-A	11-13/16" (300 mm) Extension Cable
	0335025	EFX-25-A	47-1/4" (1200 mm) Extension Cable
	0335015	EFX-17-A	126" (3200 mm) Extension Cable

NOTE: If changing flow rate, caddy and spray insert must be changed in conjunction.
 Manufactured by Sloan Valve Company under one or more of the following U.S. Patents: 7,690, 623; 7,069,941; 6,619,320.
 — in Item No. column = Not shown in illustration
 — in Code No. and Part No. column = Not sold separately

BASYS® Capacitance Sensing Activated

OPERATION OF FAUCET

A continuous ambient field is emitted and monitored by the faucet system. As the user's hands enter the effective range the sensor activates the solenoid valve allowing tempered water to flow from the faucet. Water will flow until the hands are removed or until the faucet reaches its automatic time out setting. When hands are moved away from the faucet, the capacitance sensor deactivates the solenoid valve, shutting off the water flow. The system automatically resets and is ready for the next user.

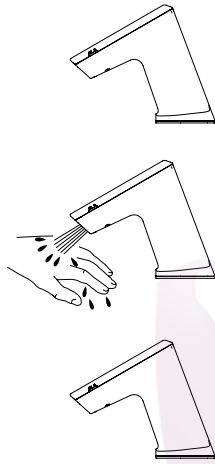

Twist top of battery pack counter-clockwise to open. Remove batteries and replace batteries with four (4) new "AA" batteries. Twist top of battery pack clockwise to close.

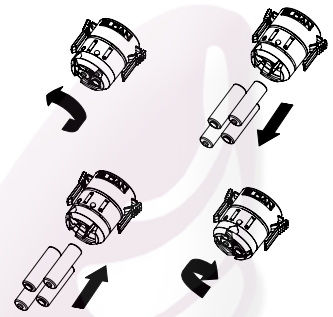

Replace cover.

BATTERY REPLACEMENT

NOTE: REPLACE BATTERY WHEN RED BATTERY INDICATOR LED FLASHES 4 TIMES EACH TIME FAUCET IS IN USE OR WHEN FAUCET STOPS FUNCTIONING.

No need to turn off water.

Loosen screw with hex wrench and remove cover.

NOTE: IT IS POSSIBLE FOR THE FAUCET TO ACTIVATE WHEN THE CAP WIRE OR SOLENOID IS TOUCHED OR WHEN THE CONTROL MODULE COVER IS BEING SCREWED ONTO THE MANIFOLD.

Slide cover forward and lift off.

Remove battery case.

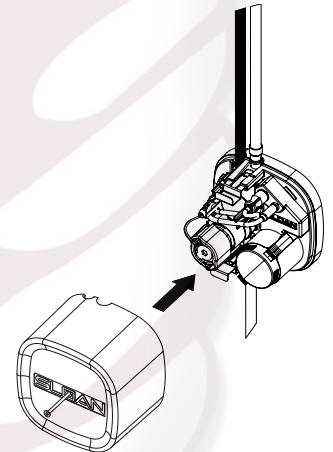
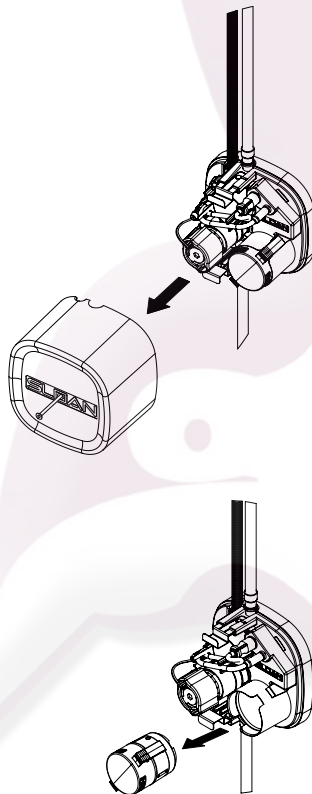

BASYS® Capacitance Sensing Activated

REPLACE FILTER

Disconnect solenoid wire from control module.

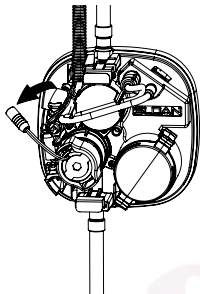

Remove new filter from control module cover.

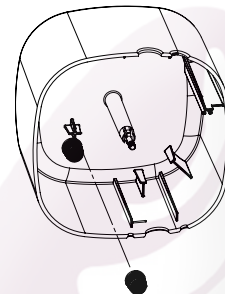

Turn solenoid caddy counterclockwise lining up arrows on control module and solenoid caddy assembly.

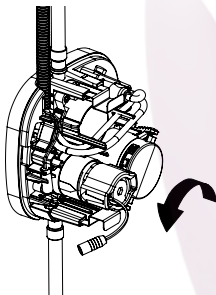

Snap new filter onto solenoid caddy assembly.

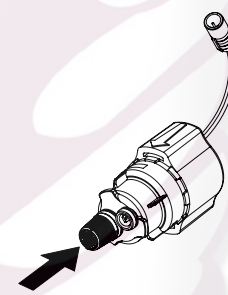

Remove solenoid caddy assembly from control module by pulling straight out.

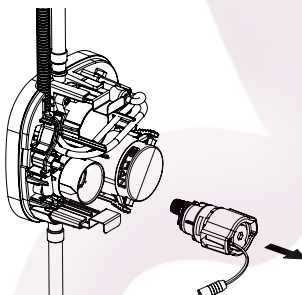

Insert solenoid caddy assembly into control module lining up arrows. Turn solenoid caddy assembly clockwise 45°.

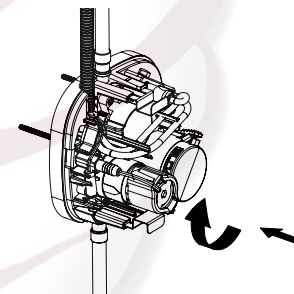

Reconnect solenoid caddy wire to control module.

Remove filter from solenoid caddy assembly.

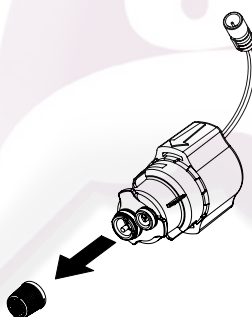

BASYS® Capacitance Sensing Activated

LED DISPLAY DIAGNOSTIC CODES

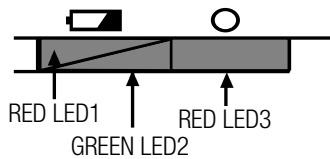

NOTE: LED1 and LED2 are for battery and programming related items. LED3 is for solenoid service.

Function	LED1	LED2	LED3	Notes
Power Up Success (Battery Only Models)		Blinks 5x		Blinks 1 every second (5 seconds); for battery power
Power Up Success (Adapter Models)	Blinks 3-5x	Blinks 3-5x		Blinks 1 every second (5 seconds); for adapter power
Low Battery	Blinks 4x			Battery power is low; During hand detection
Clean Mode		Blinks		Once every 2 seconds; Touch faucet body more than 8 seconds, water hold for 2 minutes
Water Hold		Blinks		Once every 1 second; If water turns on/off 5 times in 20 seconds, faucet turns off for 1 minute
Solenoid Latch Failure			Blinks	Two LED blinks; After hand removed from detection zone
Cap Sensor Fails to Calibrate		Blinks		4 times per second; Before first water burst Detection for cable is not installed correctly
Ambient Electrical Noise Too High		Blinks		4 times per seconds; After first water burst

TROUBLESHOOTING GUIDE

1. Faucet DOES NOT function.

- A. Batteries not installed.
Install batteries.
- B. Capacitance cable not connected.
Connect cable.

2. Faucet delivers water in an uncontrolled manner.

- A. Faucet is not working properly.
Contact Sloan Technical Support.

3. Faucet DOES NOT deliver any water when sensor is activated. Solenoid valve produces an audible “CLICK.”

- A. Water supply stop(s) closed.
Open water supply stop(s).
- B. Water supply stop strainer(s) clogged.
Remove, clean, and reinstall water supply stop strainer(s). Replace strainer(s), if required.

Solenoid valve DOES NOT produce an audible “CLICK.”

- A. Battery low (battery powered models).
Replace battery (refer to Battery Replacement section of guide).
- B. Power failure.
Check power supply.

4. Faucet DOES NOT stop delivering water or continues to drip after user is no longer detected.

- A. Valve is not working properly.
Contact Sloan Technical Support.

5. Faucet delivers only a slow flow or dribble when sensor is activated.

- A. Water supply stop(s) are partially closed.
Completely open water supply stop(s).
- B. Water supply stop strainer(s) clogged.
Remove, clean, and reinstall water supply stop strainer(s). Replace strainer(s), if required.
- C. Spray head is clogged.
Remove, clean, and reinstall spray head. Replace spray head, if required.
- D. Faucet is not working properly.
Contact Sloan Technical Support.

6. LED indicator blinks when faucet is in use.

- A. Battery low (battery powered models).
Replace battery (refer to Battery Replacement section of guide).

7. The water temperature is too hot or too cold on a faucet connected to hot and cold supply lines.

- A. Supply stops are not adjusted properly.
Adjust supply stops.

CARE AND CLEANING

DO NOT USE abrasive or chemical cleaners (including chlorine bleach) to clean faucets that may dull the luster and attack the chrome or special decorative finishes. Use **ONLY** mild soap and water, then wipe dry with clean cloth or towel. While cleaning the bathroom sink, protect the faucet from any splattering of cleaner. Acids and cleaning fluids will discolor or remove chrome plating.

When assistance is required, please contact Sloan Technical Support at: 1-888-SLOAN-14 (1-888-756-2614).