



Buy it for looks. Buy it for life.®

Specifications

FAUCET DESCRIPTION

- Metal construction with chrome finish
- 1/2" IPS connections

OPERATION

- Lever style handles
- Maximum handle rotation angle is 90° to full on for either handle
- Hot side counterclockwise to open (clockwise to close)
- Cold side clockwise to open (counterclockwise to close)
- Includes hot and cold temperature indicators

FLOW

- Flow is limited to 1.2 gpm max (5.7L/min) at 60 psi

CARTRIDGE

- 1234 cartridge design
- Nonmetallic, nonferrous and stainless steel material

STANDARDS

- Third party certified to WaterSense®, ASME A112.18.1/CSA B-125.1, and all requirements referenced therein
- Certified to NSF 61/9 & 372
- Complies with California Proposition 65 and with the Federal Safe Drinking Water Act
- **ADA**  for lever handle

WARRANTY

- Lifetime limited warranty against leaks, drips and finish defects to the original consumer purchaser
- 5 year warranty if used in commercial installations

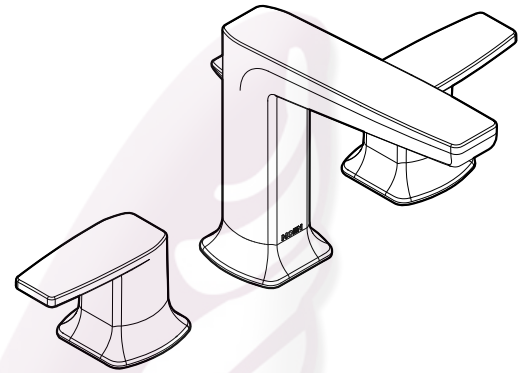

Via™
Two Handle Widespread
Lavatory Faucet Trim

Model: TS8002

Valve: 9000, 69000



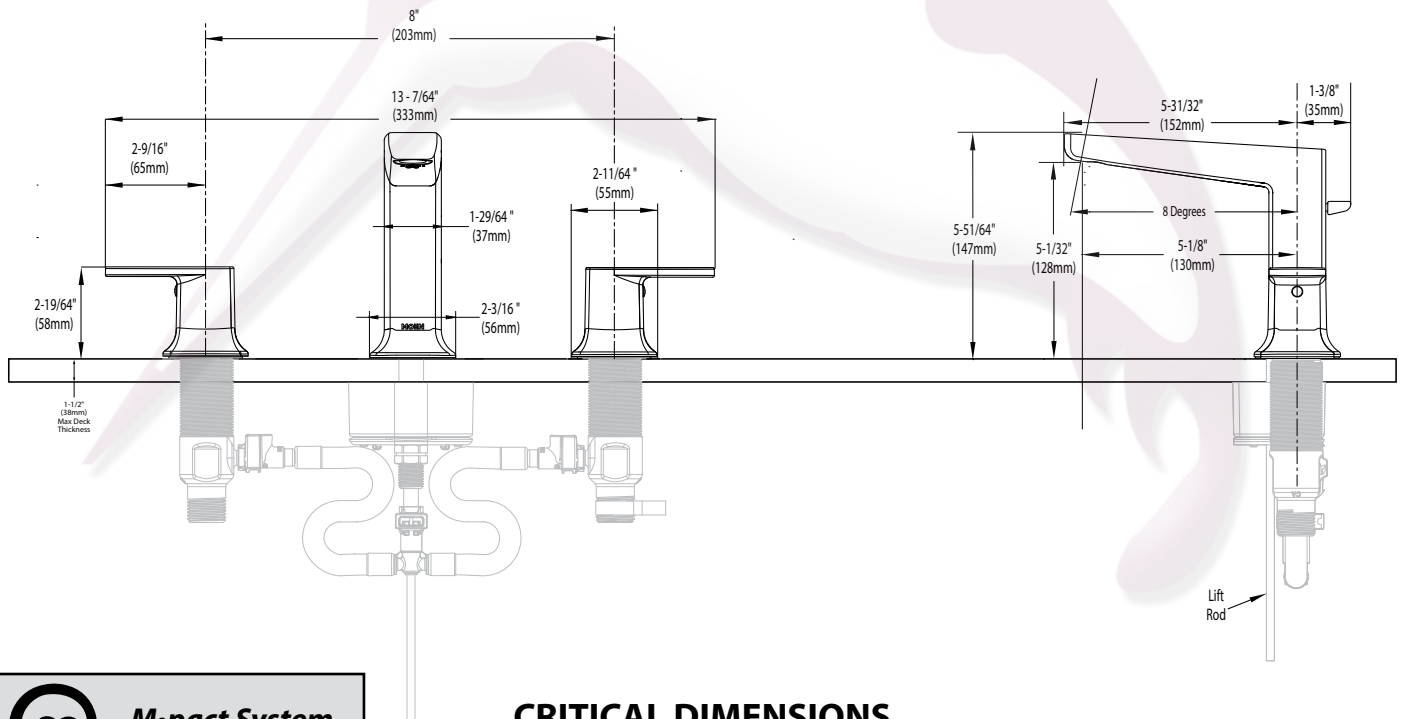

NOTE: THIS FAUCET IS DESIGNED TO BE INSTALLED THRU 3 HOLES, 1-1/8" MIN. DIA.



CRITICAL DIMENSIONS

(DO NOT SCALE)



Tel.8375.0992/93, 8372.3713/14/15
 Prol.Ruiz Cortines #307 Pte. Col.Paseo de Cumbres Mty N.L. C.P.64346
 www.colibrimty.com       colibrimty