

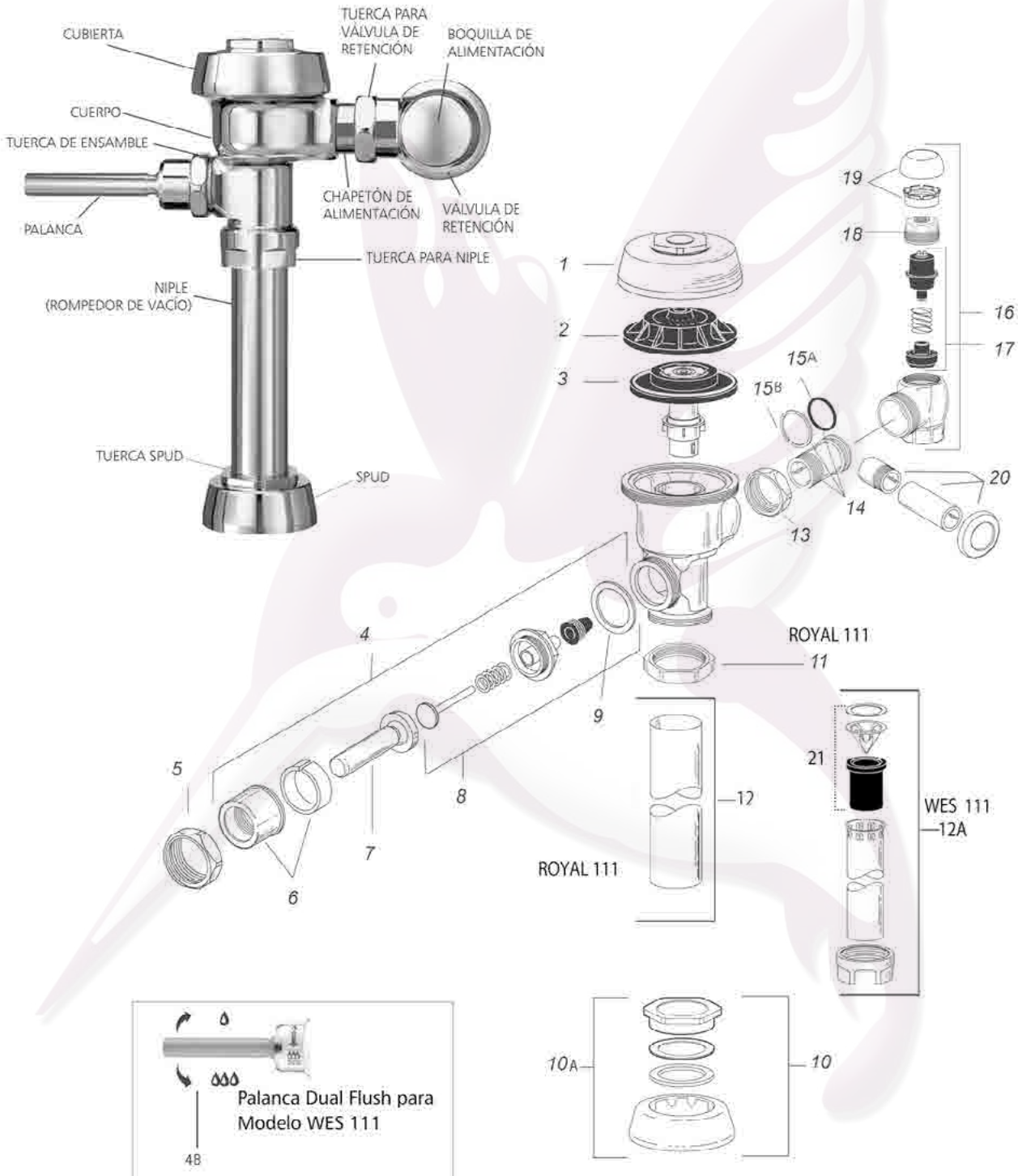

























ROYAL 111 / WES 111

SANITARIO



FLUXÓMETRO MANUAL SANITARIO

	Número	Código	Parte	Descripción
	1	0301172 PK	A-72	Cubierta cromada
	2	0301168	A-71	Cubierta interior
	3	3301502	A-1041-A	Diafragma para sanitarios 6.0 Lts
		3301506	A-1045-A	Diafragma para sanitarios 4.8 Lts
	4A	0302390	B-73-A	Ensamble palanca para fluxómetro Royal 111
	4B	3372003	WES-212	Palanca doble descarga para fluxómetro WES 111
	5	0301082 PK	A-6	Tuerca unión ensamble de palanca
	6	0302109	B-7-A	Ensamble tuerca para palanca
	7	0302389 PK	B-74-A	Palanca (cumple con requerimiento ADA)
	8	3302306	B-51-A	Juego reparación de palanca
	9	5301139	A-31	Empaque palanca
	10	0306146	F-5-AT	Chapetón y tuerca para unión de Spud 1-1/2" (38mm)
		5306058	F-3	Anillo rojo de fricción 1-1/2"
		0396264	F-105	Empaque rígido 1-1/2" x 1-1/4"
		5306057	F-3	Anillo rojo de fricción 1-1/4"
	11	0306093	F-2-A	Tuerca unión de nipple recto de 1 1/2" para fluxómetro Royal 111
	12	0396113 PK	F-101	Nipple recto cromado de 1 - 1/2" x 9" para fluxómetro Royal 111
	12A	3393007	V-600-AA	Nipple recto con rompedor de vacío de 1-1/2" x 9" para WES 111
	13	0308676 PK	H-550	Tuerca unión para válvula de retención
	14	0308801	H-551-A	Boquilla ajustable de 2 - 1/16" (52mm)
	15A	5308696	H-553	Empaque redondo para boquilla ajustable (24 pzas por paquete)
	15B	5308381	H-552	Anillo sellador (12 pzas por paquete)
	16	3308386	H-700-A	Válvula de retención de 1 con tapa antivandalismo 1"
	17	3308853	H-541-ASD	Juego reparación de válvula retención 1" cromo
	18	0308612 PK	H-622	Tapa con orificio de tornillo para válvula retención 1"
	19	3308772	H-1010-A	Tapa cromada antivandalismo para válvula retención 1" antivandalismo
	20	3308785	H-634-AA	Chapetón con nipple para válvula retención de 1"
	21	3323182	V-651-A	Rompedor de Vacío

Tel. 8375.0992/93, 8372.3713/14/15

ProL.Ruiz Cortines #307 Pte. Col. Paseo de Cumbres Mty N.L. C.P.64346

www.colibrimty.com      @colibrimty