

# EAF-275/250 DE BATERÍAS

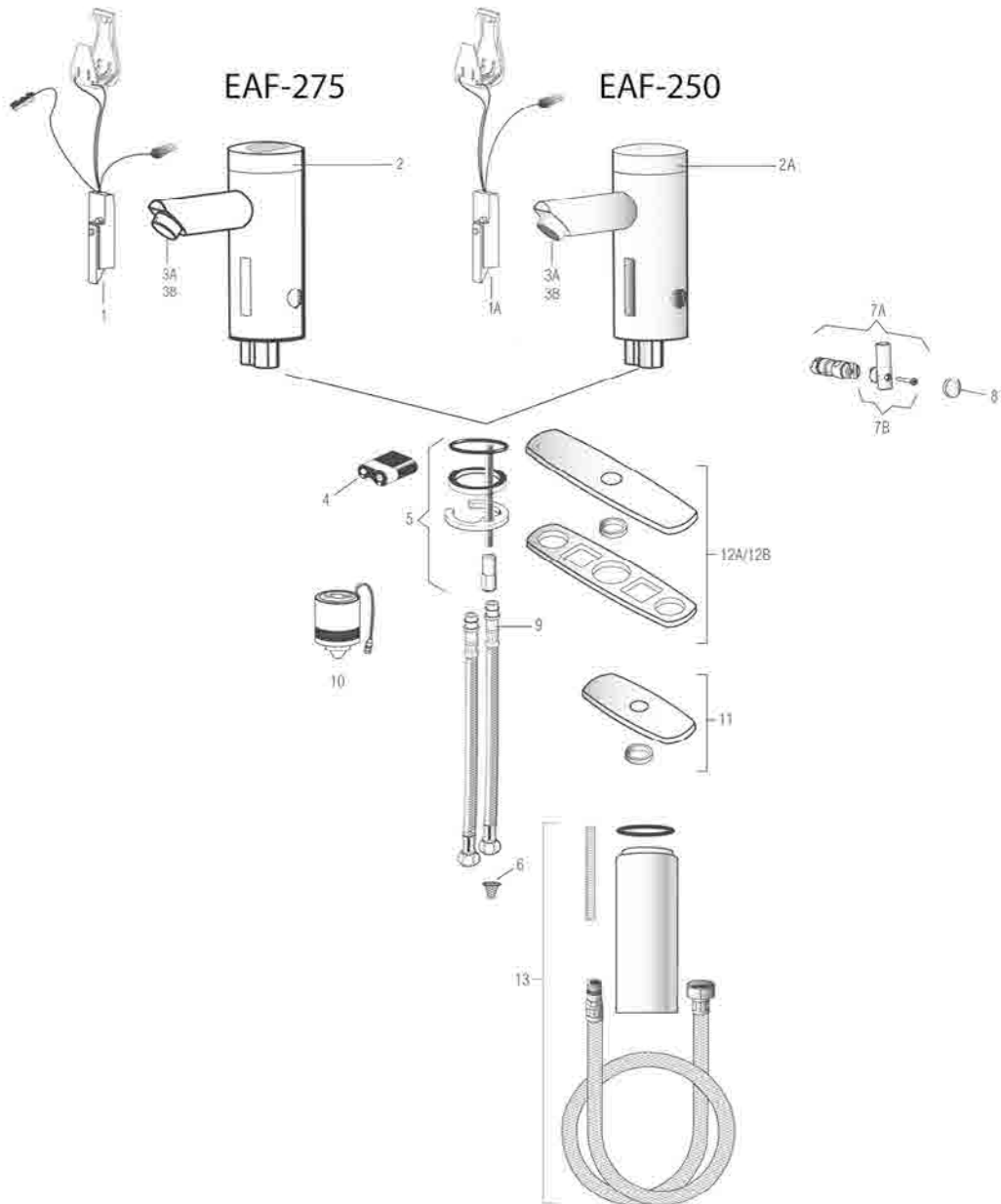















## EAF-250



# LLAVES AUTOMÁTICAS

## BATERIAS

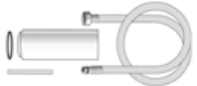
	Número	Código	Parte	Descripción
	1	<b>0335013</b>	EAF-14-A	Sensor para llave EAF-275
	1A	<b>0335019</b>	EAF-21-A	Sensor para llave EAF-250
	2	<b>3335021</b>	EAF-1006	Tapa con celda solar EAF-275
	2A	<b>0335027</b>	EAF-27	Tapa para llave EAF-250
	3A	<b>0335012</b>	EAF-15	Aerador de 0.5 gpl
	3B	<b>0335008</b>	EAF-10	Aerador en spray de 2.2 gpl
	3C	<b>0335011</b>	EAF-13	Aerador laminar 2.2 gpm
	4	<b>3335018</b>	EAF-1003	Batería
	5	<b>0335000</b>	EAF-1	Herraje de montaje para grifo
	6	<b>0335007</b>	EAF-9	Filtro de manguera
	7A	<b>3335019</b>	EAF-1004	Ensamble de palanca con cartucho
	7B	<b>3305020</b>	EAF-1005	Ensamble de palanca
	8	<b>3335022</b>	EAF-1007	Tapón de palanca
	9	<b>3335023</b>	EAF-1008	Manguera flexible
	10	<b>0335001</b>	EAF-2	Solenoid de módulo
	11	<b>3365468</b>	ETF-312-A	Placa de 4"
	12A	<b>3365024</b>	ETF-510-A	Placa de 8"
	12B	<b>3362022</b>	SFP-22-A	Uso cuando requiere extensión de 8" para EAF-35-A
	13	<b>3335035</b>	EAF-35-A	Kit de extensión de llave

Tel.8375.0992/93, 8372.3713/14/15

Prol.Ruiz Cortines #307 Pte. Col.Paseo de Cumbres Mty N.L. C.P.64346

www.colibrimty.com      @colibrimty