

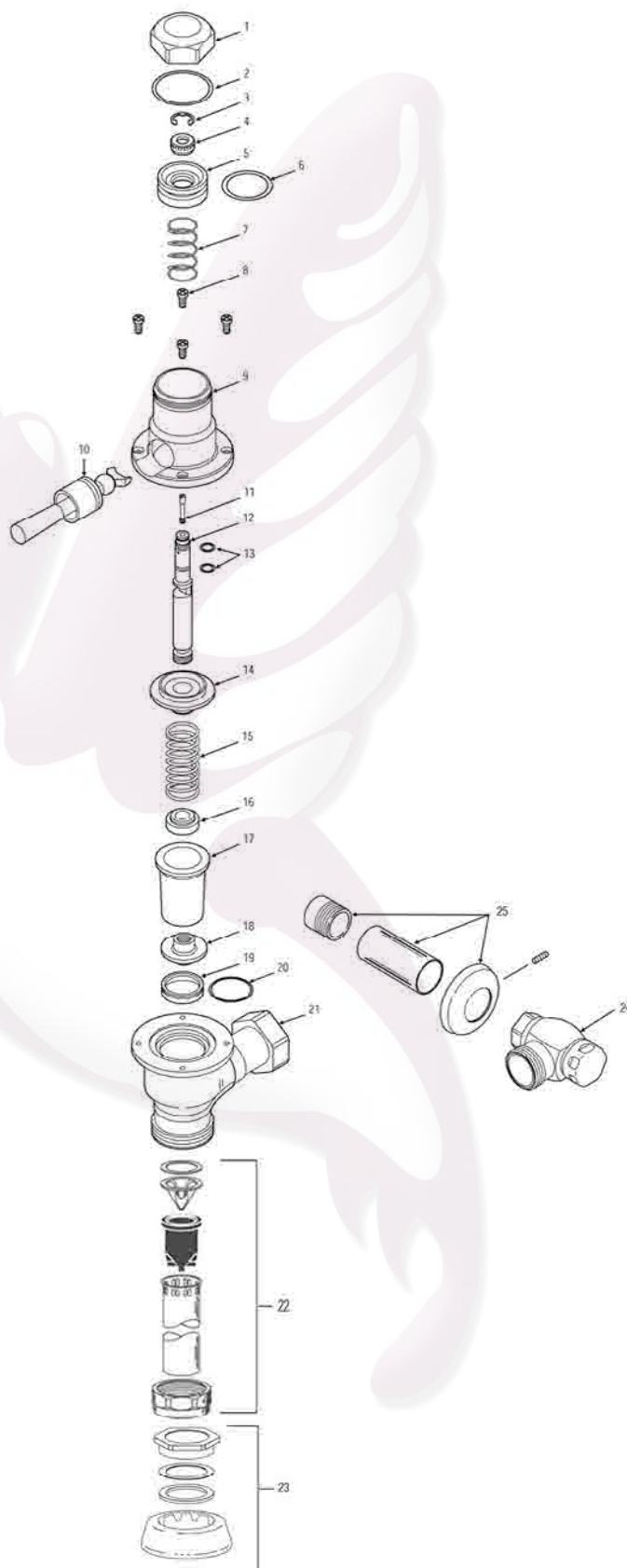

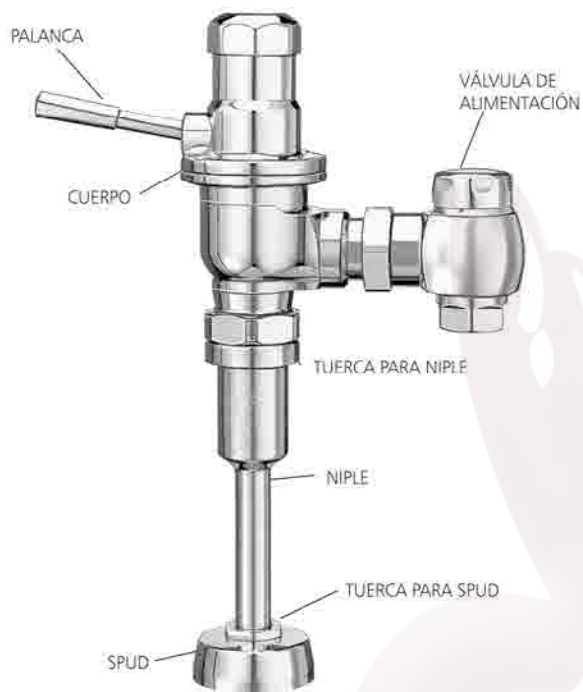



















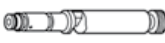

DOLPHIN 186

MINGITORIO



FLUXÓMETRO MANUAL

MINGITORIO

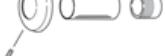
	Número	Código	Parte	Descripción
	1	0337007	DO-1	Tapa
	2	5337125	DO-2	Empaque de tapa (6 pzas x paquete)
	3	5337129	DO-28	Candado retenedor
	4	5337006	DO-4	Tuerca de vástago (6 pzas x paquete)
	5	0337004	DO-5	Pistón
	6	5337075	DO-6	Empaque de pistón (6 pzas x paquete)
	7	5337039	DO-7	Resorte de pistón
	8	5337011	DO-11	Tornillos para tapa de cuerpo* (24 pzas x paquete)
	9	0337003 PK	DO-10	Cuerpo superior cromado
	10	0337042	DO-20	Ensamble de palanca cromada
	11	5337126	DO-3	Tornillo regulador (1 requerido)
	12	0337087	DO-9	Vástago
	13	5328336	SH-75	Empaque regulador (O-Ring)**
	14	0337005 PK	DO-14	Casquillo guía
	15	0337009	DO-16	Resorte de compresión
	16	5337034	DO-17	Inserto (6 pzas x paquete) se requiere 1 pz
	17	0337018	DO-15	Cavidad flexible
	18	0337084	DO-18	Tuerca retenedora
	19	0337036	DO-19	Ensamble de asiento c/empaque O-Ring
	20	0337086 PK	DO-22	Empaque O-Ring de asiento
	21	0337032 PK	DO-13-NU	Cuerpo inferior para sanitario
	22	0323004	V-500-AA	Niple recto con rompedor de vacío 3/4" x 10 -1/2"
	23	0306125	F-5-AW	Chapetón y tuerca unión de spud de 3/4"
	24	0388022	H-710-A	Válvula de retención de 1"
	25	3308782	H-633-A	Chapetón y niple para válvula de retención

Tel.8375.0992/93, 8372.3713/14/15

ProL.Ruiz Cortines #307 Pte. Col.Paseo de Cumbres Mty N.L. C.P.64346

www.colibrimty.com      @colibrimty