

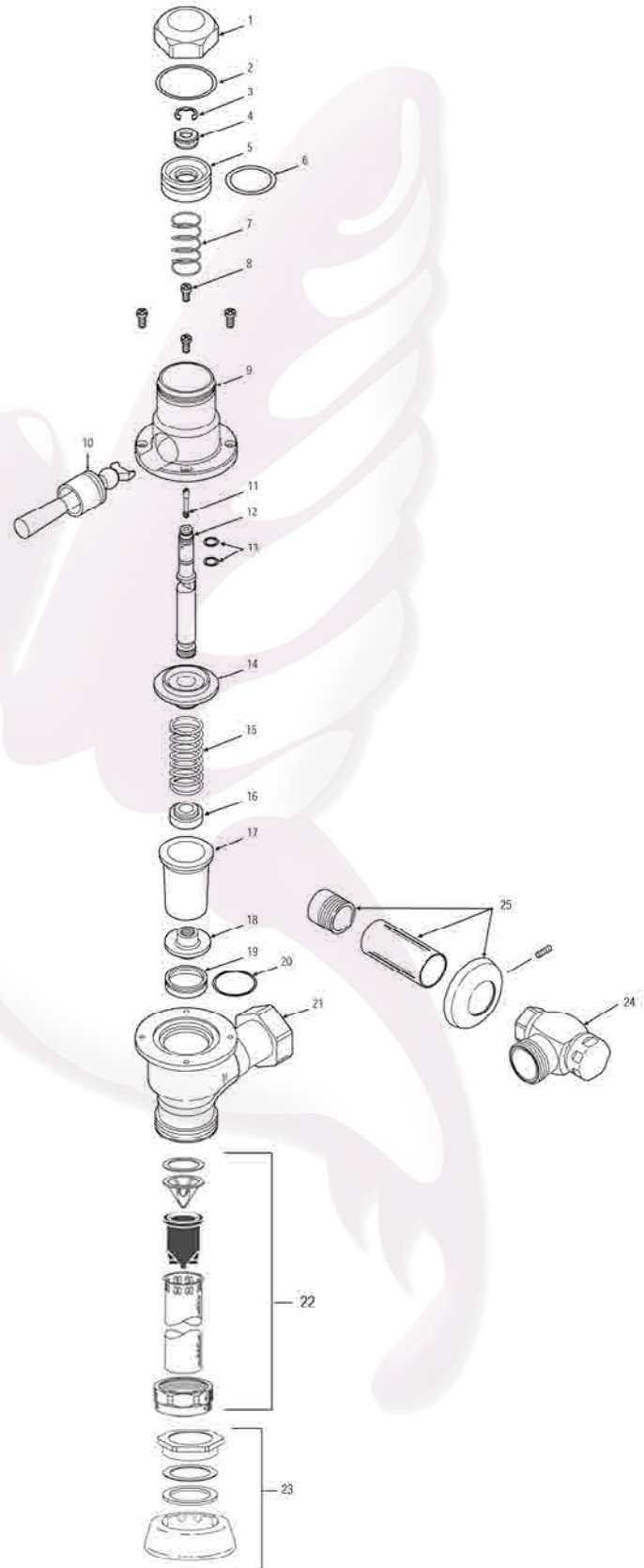

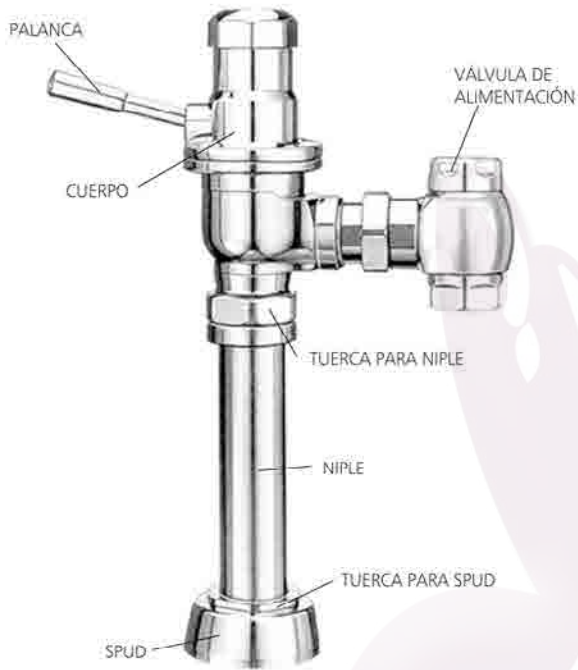























DOLPHIN 111

SANITARIO

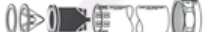

FLUXÓMETRO MANUAL SANITARIO

	Número	Código	Parte	Descripción
	1	0337007	D0-1	Tapa
	2	5337125	D0-2	Empaque de tapa (6 pzas x paquete)
	3	5337129	D0-28	Candado retenedor
	4	5337006	D0-4	Tuerca de vástago (6 pzas x paquete)
	5	0337004	D0-5	Pistón
	6	5337075	D0-6	Empaque de pistón (6 pzas x paquete)
	7	5337039	D0-7	Resorte de pistón
	8	5337011	D0-11	Tornillos para tapa de cuerpo * (24 pzas x paquete)
	9	0337003 PK	D0-10	Cuerpo superior cromado
	10	0337042	D0-20	Ensamble de palanca cromada
	11	5337126	D0-3	Tornillo regulador (1 requerido)
	12	0337087	D0-9	Vástago
	13	5328336	SH-75	Empaque regulador (O-Ring)**
	14	0337005 PK	D0-14	Casquillo guía
	15	0337009	D0-16	Resorte de compresión
	16	5337034	D0-17	Inserto (6 pzas x paquete) se requiere 1 pz
	17	0337018	D0-15	Cavidad flexible
	18	0337084	D0-18	Tuerca retenedora
	19	0337036	D0-19	Ensamble de asiento c/empaque O-Ring
	20	0337086 PK	D0-22	Empaque O-Ring de asiento
	21	0337031 PK	D0-13-NC	Cuerpo inferior para sanitario
	22	0323013	V-500-AA	Niple recto 1 - 1/2" x 10 1/2"
	23	0306146	F-5-AT	Chapetón y tuerca unión de spud de 1 - 1/2"
	24	0388022	H-710-A	Válvula de retención de 1"
	25	3308782	H-633-AA	Chapetón y niple para válvula de retención 1"

Tel.8375.0992/93, 8372.3713/14/15

Prol.Ruiz Cortines #307 Pte. Col.Paseo de Cumbres Mty N.L. C.P.64346

www.colibrimty.com      @colibrimty